

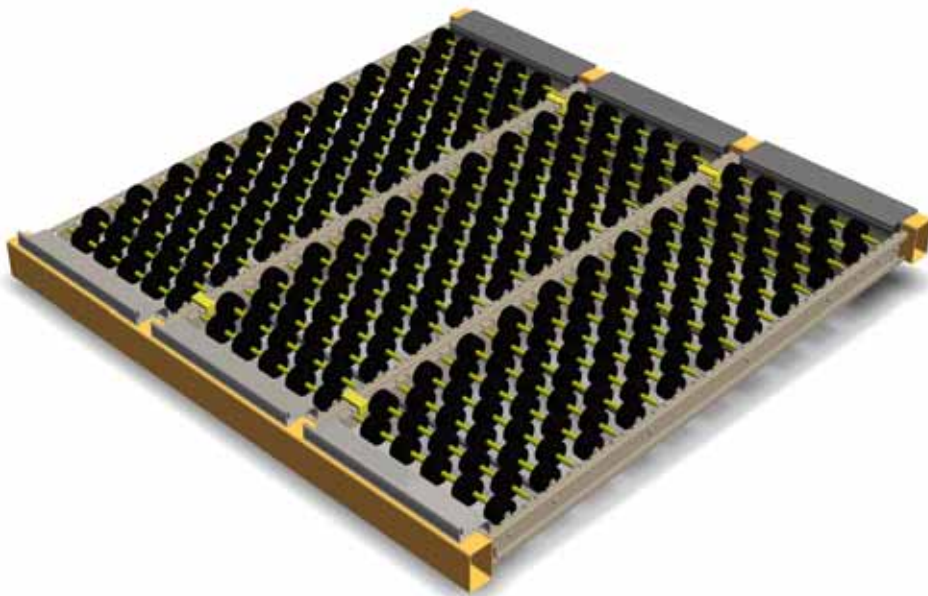

INSPIRED BY  
EFFICIENCY



# User manual

## Interroll Carton Versi Flow

**Manufacturer**

Interroll Dynamic Storage  
310, rue du Clair Bocage  
Zone d'Activité Beaupuy 2  
85000 Mouilleron le Captif  
France  
Tel. +33 251 37 12 32  
Fax +33 157 67 99 71  
[www.interroll.com](http://www.interroll.com)  
[dynamicstorage@interroll.com](mailto:dynamicstorage@interroll.com)

**Copyright for the operating instructions**

Interroll Dynamic Storage enjoys intellectual property rights. These operating instructions contain standards, plans and drawings that must not be divulged, published, duplicated partially or entirely, or used for any purpose other than the use of the installation to which these operating instructions refer, except with prior, written consent from Interroll.

**Manual may be downloaded at the following address:**

[http://www.interroll.com/en/downloads/dynamic\\_storage/ds\\_user\\_manual/](http://www.interroll.com/en/downloads/dynamic_storage/ds_user_manual/)

## Contents

### About this document

Notes relating to the use of the operating instructions.....	4
Warnings in this document.....	5
Other symbols.....	5

### Safety

Basic safety instructions .....	6
Compliant use .....	6
Non-compliant use .....	6
Qualified personnel .....	7
Hazards.....	7

### Information about the product

Product description .....	8
Components.....	8
Technical characteristics of the Carton Versi Flow .....	9

### Transportation and storage

Transportation.....	11
Storage .....	11

### Assembly and installation

Warnings relating to the assembly.....	12
Assembly rules.....	12
Proper operation report.....	15
Assembly .....	16

### Commissioning and operation

Warnings relating to the operation .....	21
Inspections before the first commissioning .....	22
Operation .....	22
Loading and unloading method.....	24

### Cleaning, maintenance and repair

Cleaning.....	26
Note in case of maintenance and repair .....	26
Maintenance and inspection list.....	27

### Troubleshooting

In case of breakdown.....	29
Troubleshooting .....	30

### Disabling and discarding

Waste removal.....	31
--------------------	----

### Appendix

Spare parts .....	32
-------------------	----

## About this document

### Notes relating to the use of the operating instructions

#### Contents of the operating instructions

These operating instructions contain important notes and information about the various phases of operation of the Carton Versi Flow:

- Transportation, installation and commissioning
- Safe operation, maintenance, troubleshooting, waste disposal

#### Validity of the operating instructions

The operating instructions describe the Carton Versi Flow at the time of its delivery by Interroll.



**In case of an installation corresponding to non-standard containers or contents, the specific recommendations, specific operating modes and all contractual documents are added to this document.**

#### The operating instructions are an integral part of the product

- To guarantee an interference-free and safe operation and to benefit from the guarantee, before using the Carton Versi Flow, respect the instructions of this operation mode especially the instructions of the chapter *Assembly and installation, page 12*, and the order confirmation data.
- Keep the operating instructions close to the Carton Versi Flow.
- Pass on the operating instructions to every operator or eventual user of the Carton Versi Flow.
- Interroll declines all responsibility for damage or failures likely to result from a failure to observe these operating instructions.
- Contact the Interroll customer service if you have any questions after reading the operating instructions. You will find the details of the persons to be contacted in your country on the last page.

### Warnings in this document

The warnings in this document warn about the hazards inherent in using the Carton Versi Flow. You will find the concerned warnings in the chapter *Safety*, page 6, and at the beginning of each chapter.

The warnings have three levels. You will recognise the following keywords:

- Danger
- Warning
- Caution

Keyword	Meaning
Danger	Warns about a directly threatening danger, which, if not avoided, results in death or serious bodily injury.
Warning	Warns about a directly threatening danger, which, if not avoided, may result in death or serious bodily injury.
Caution	Warns about a directly threatening danger, which, if not avoided, could result in minor injuries.

### Configuration of a warning



**Danger**  
**You find here the type and source of the danger**  
 You see here the possible consequences of a failure to observe the warning.  
 ► You see here the measures enabling to neutralize the danger.



**Recommendation**  
**This warning draws the attention to possible material damage**  
 ► You see here the measures enabling to avoid this material damage.

### Other symbols



This symbol draws the attention to a comment relating to the safety.



This symbol draws the attention to important information.

- This symbol draws the attention to an action to be executed.

## Safety

### Basic safety instructions

The Carton Versi Flow even if assembled by the rule book may present certain dangers when used:

- Injuries or fatal accident to the user or third party
- Damage caused to the Carton Versi Flow or other physical assets



**Failure to observe the instructions contained in these operating instructions may lead to serious injuries.**

- ▶ Please read the operating instructions carefully and respect the safety instructions.
- ▶ As a result, the use of Carton Versi Flow must be entrusted to trained and qualified personnel.
- ▶ Ensure that the operating instructions are not kept away from the place of use, and are accessible to all.
- ▶ Ensure that the current legislation in your company is always respected.
- ▶ Contact the Interroll customer service if you have any questions after reading the operating instructions. You will find the persons to be contacted in your country on the last page.

### Compliant use

The Carton Versi Flow is reserved exclusively for industrial use and in suitable environments. The modules installed are designed exclusively for dynamic storage (gravity) of isolated loads provided for and validated beforehand. They are reserved exclusively for the storage of referenced or standardised containers. Any other use may be declared non-compliant.

The installation configurations must be respected. They are defined in the order confirmation and in the current operating instructions. Any modifications concerning the components and their locations in the module are not authorised.



**Respect the maximum loads recommended by the manufacturer of the shelving and indicated on the load plate. The contents may on no account be greater than the maximum load defined by the supplier of the container or by the standard.**

### Non-compliant use

The Carton Versi Flow is not suitable for transporting persons.

Applications not compliant with the intended use of the Carton Versi Flow require prior written approval from the Interroll.

## Qualified personnel

By qualified personnel, we mean persons capable of reading and understanding the operating instructions and executing the work by the rules taking the current legislation into account.

The use of the Carton Versi Flow must be entrusted to personnel qualified and trained in the product, considering the following:

- Corresponding manuals and drawings
- Safety instructions of the operating instructions
- Prescriptions and provisions specific to the installation, see *Assembly and installation, page 12*
- The current legislation relating to occupational safety and accident prevention

## Hazards



**You will find below information relating to various types of hazards or damage likely to occur, when installing and using the Carton Versi Flow.**

### Bodily injury

- ▶ The equipment in all its operating modes must be used by qualified personnel.
- ▶ Respect the technical data described in the offer and the order confirmation. The rigidity of the container must be adapted to the weight of the contents. The dimension ratio between the base and the height must ensure good stability of the container.
- ▶ Respect the installation and operating instructions.
- ▶ Use only suitable handling equipment.
- ▶ Check and maintain the installation regularly.
- ▶ Ensure that there is no one under the loads, in the unloading and loading areas of dynamic storage modules. Take the necessary measures to prevent the presence of personnel inside the modules.
- ▶ Ensure that the loading/unloading aisle is sufficiently lit so as not to hamper the handling operation.
- ▶ Do not lean, climb or walk on the Carton Versi Flow modules and components.

### Rotating parts

- ▶ Wear appropriate work clothes and Personal Protective Equipment (safety footwear, gloves, leggings, etc.)
- ▶ In case of work in areas with controlled temperatures, use suitable clothing and PPE.
- ▶ Tie long hair or wear a mob-cap.
- ▶ Do not wear jewellery such as necklaces or bracelets.

## Information about the product

### Product description

The Carton Versi Flow offers solutions suitable for handling and preparing light load orders.

The product consists of roller pins fixed on a rigid module.  
You will find below the main components of Carton Versi Flow.

### Components

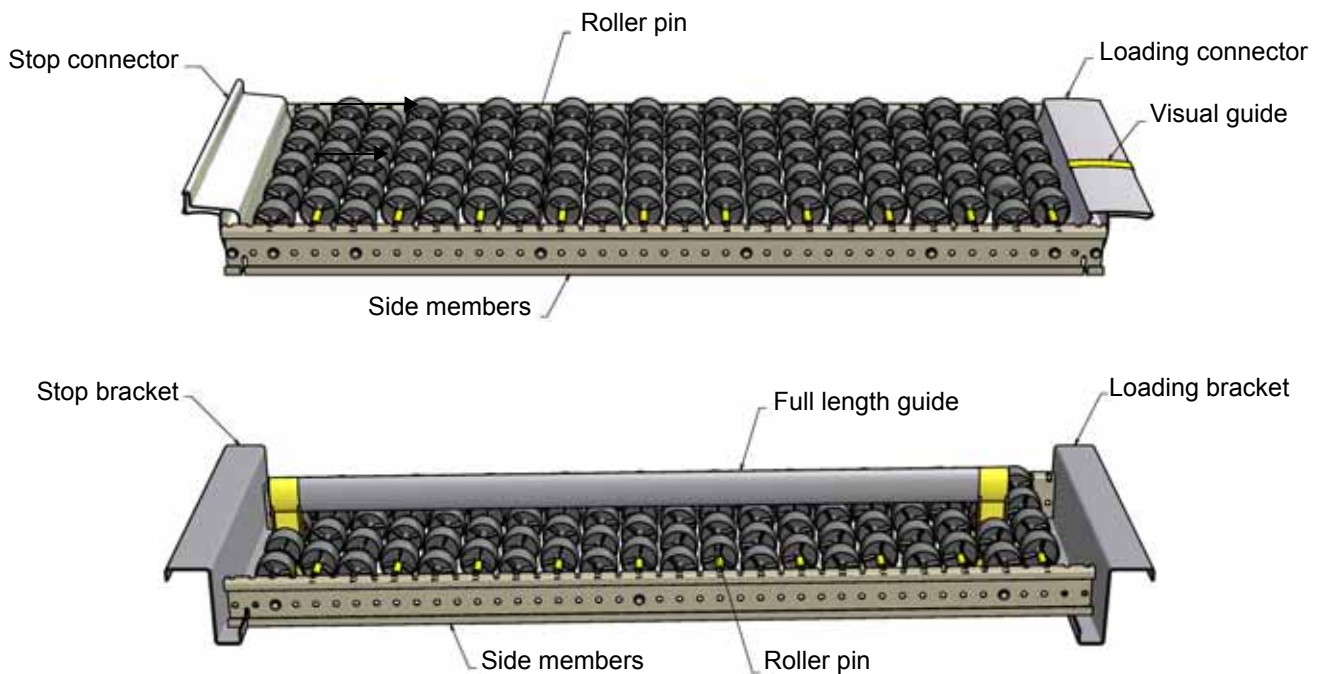



**Technical characteristics of the Carton Versi Flow**

**Gravity system**

**Loads**

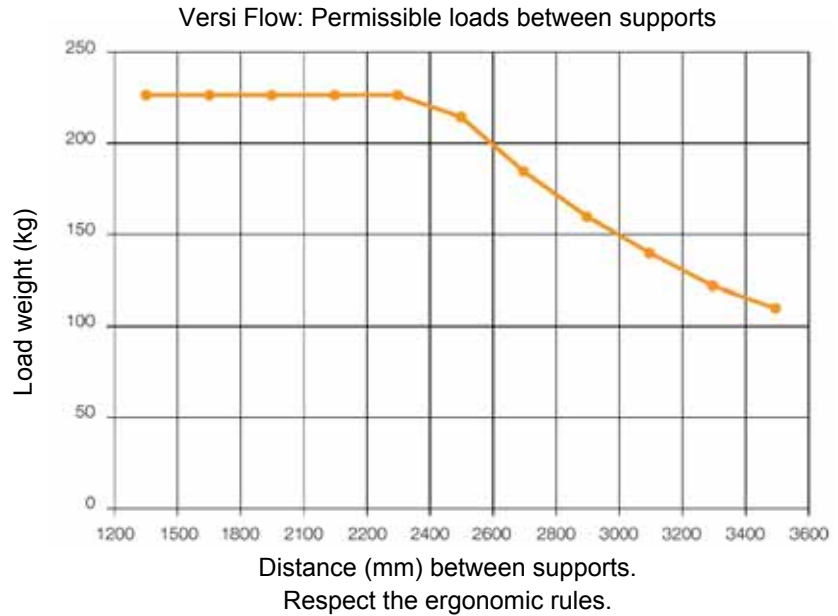

Module slope	Recommended slope 3 to 4.5% for plastic trays 4 to 5.5% for cardboard boxes 5.5 to 7% for KLT trays <i>see "Inspections before the first commissioning", page 22</i>
--------------	--

Handling methods	Manual, except if specified otherwise in the order confirmation
------------------	---

**Ambient conditions**

Ambient temperature	in operation	-30 °C to +45 °C
	of the assembly	-30 °C to +45 °C
	of transport and storage	-30 °C to +80 °C
Relative humidity	Up to 90% max., without condensation	

---

Environment	<p>The Carton Versi Flow is not suitable for use in an environment with the following risks:</p> <ul style="list-style-type: none"><li>• Oxidation (atmospheric or by chemical attacks)</li><li>• Projection</li><li>• Decomposition</li><li>• Vibration</li><li>• Explosion</li><li>• Radiation</li><li>• Emission</li></ul> <p>Exceptions are possible after consulting Interroll.</p>
-------------	--

---

- Composition of loads** The composition of loads and their containers must not:
- Oxidise
  - Corrode
  - Decompose
  - Block components of the module
  - Hinder the proper operation of all mechanisms
- The Carton Versi Flow must not be used in direct contact with food products.

## Transportation and storage

### Transportation

- ▶ Have only qualified and authorised personnel carry out the transportation.
- ▶ Transportation with suitable hoisting equipment.
- ▶ The weight of each pallet is indicated on it.

### Storage

- ▶ Store the equipment indoor.
- ▶ Never store the equipment outdoor, or in an area exposed to dust and spatter.
- ▶ Respect the ambient conditions, see "*Technical characteristics of the Carton Versi Flow*", page 9.
- ▶ Do not stack additional loads on the pallets and crates containing the Carton Versi Flow and its components.

## Assembly and installation

### Warnings relating to the assembly



#### Warning

##### Risk of injury in case of incorrect assembly

- ▶ The Carton Versi Flow being a sub-system of a complete installation, carry out the risk analysis of the complete installation.
- ▶ Study the protective measures necessary with respect to the risks linked to the local installation and operating conditions.
- ▶ Define a safety zone for the work area.
- ▶ Secure the area and install a sign and a suitable protection.
- ▶ For the assembly of modules on the shelving, refer to the safety rules relating to work at a height.
- ▶ Do not lean, climb or walk on the Carton Versi Flow components.
- ▶ During the entire duration of the installation, wear suitable Personal Protective Equipment (gloves, leggings, safety footwear, etc.).

### Assembly rules

The dynamic storage modules are sub-systems of a complete installation. They are delivered in accordance with the technical data specified in the order confirmation.

The delivery of the Carton Versi Flow consists of roller modules and accessories. These components must be assembled and installed on a shelving.



**Any modification concerning the components or the modules relieves Interroll from its responsibility and will be considered as a non-compliant use of Carton Versi Flow.**

#### Qualified personnel

The assembly and installation must be carried out by qualified personnel in accordance with the instructions of these activities and with the safety instructions. The manager of the personnel responsible for the assembly of modules must be technically competent and trained for the following:

- Products and their use
- Dangers inherent in the assembly of heavy or bulky elements at great height
- Risks resulting from faulty assembly
- Adjustments required for the proper operation of modules.



**Interroll is available to provide you training dedicated to Carton Versi Flow. An estimate will be sent to you on request.**

- General rules**
- ▶ Follow the safety instructions in the work area.
  - ▶ Check the stability of components on the containers before cutting the strapping.
  - ▶ Once the strapping is cut, do not handle the container.
  - ▶ Ensure that the components are not damaged during assembly.
  - ▶ The dimension ratio between the base and the height must ensure good stability of the container.
  - ▶ Before fixing or suspending an equipment (e.g., a sprinkler) in the volume occupied by the dynamic storage installation, consult Interroll beforehand (except label holder and pick to light batten)
  - ▶ In case brackets not provided by Interroll are used, the user must study the risks inherent in the interface and the potential risks between the interface and the Versi Flow modules
  - ▶ Clean the work site at the end of installation. Do not leave any components or tools around the installation.
  - ▶ When using a full length guide leave a minimum gap of 10 mm between the container and the guide.

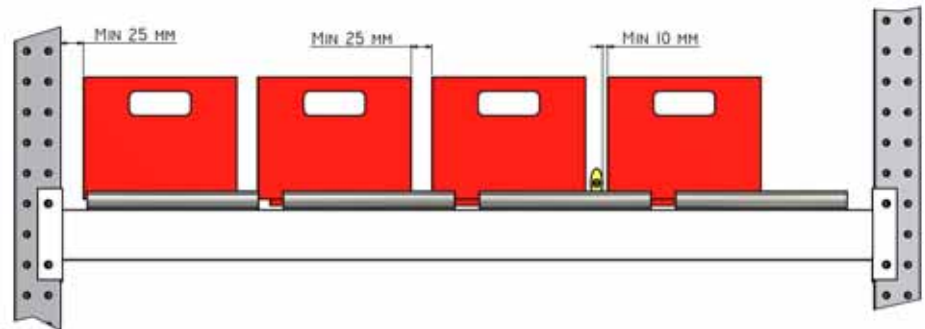

- ▶ The distance between the 2 modules must be less than the smallest dimension of the smallest container.

## Adjusting the slope:

- ▶ 3 to 4.5 % for plastic trays/4 to 5.5 % for cardboard boxes/ 5.5 to 7 % for KLT trays

## Tests:



**Carry out the tests in the presence of the manager of the assembly team and a manager representing the user.**

A report of the proper operation of lanes and the validation of the installation must be prepared. The end user must countersign this report.

Send a copy of the report to Interroll. See a copy of the proper operation report page 15.



**The proper operation report validates the guarantee. In the absence of the proper operation report, Interroll will not be able to guarantee the installation.**

Carry out the following tests with the lightest and heaviest loads.

**Install a module and carry out the following functional tests before assembling the rest of the installation.**

- ▶ Place the load on the module on the loading side.
- ▶ Check that the load does not deviate from its axis during its descent.
- ▶ When stopped at the abutment:
  - The contents must remain inside the container
  - The container must stop at the abutment without damaging the contents
  - The impact must be acceptable, not sudden, without damaging the container. If necessary, adjust the slope of the modules.
- ▶ Check that the container at the abutment can be removed while others are accumulating in the same module.
- ▶ During the removal of a container on the facade, the containers accumulating behind must descend.
- ▶ Respect a minimum free space above the container all along the lane.
  - Plastic container: 30 mm
  - Cardboard container: 50 mm

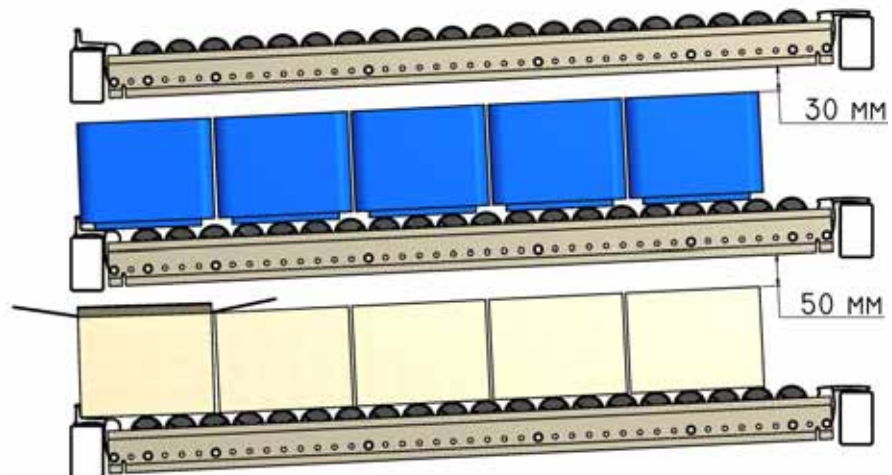

**Proper operation report**

**Proper operation report - Carton Versi Flow**

The proper operation report validates the guarantee of the dynamic storage modules supplied by Interroll. A copy of this report countersigned by the assembly manager, by the operator or shelving manufacturer must be sent to Interroll at the most within 4 weeks after delivery of the equipment.

**Interroll SAS – Customer service**

310 rue du clair bocage  
 BP255 Mouilleron le Captif  
 F-85006 La Roche-sur-Yon, Cedex  
*dynamicstorage@interroll.com*

The tests must be carried out in the presence of the assembly manager, operator or the shelving manufacturer. Respect the data described in the conditions initially provided for in the contract; max. and min. loads, loading and unloading method, containers. All 5 tests described below must be validated for the guarantee to be effective.

**Follow the instructions for the lane tests described in the user manual page 14**

**Compliant**

- 1- Acceptable impact of the container on the final stop
- 2- Holding of the contents in the container
- 3- Restarting of loads
- 4- Proper operation of the separator
- 5- Acceptable load accumulation pressure

**OF no.** \_\_\_\_\_

Enter the OF number indicated on the labels affixed on the module pallets

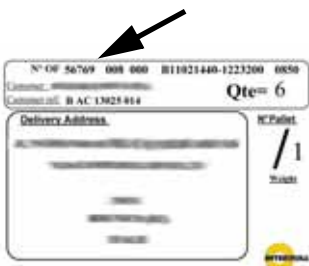

**The assembly manager**

Last name/first name:  
 Company:  
 Date:  
 Signature

**The operator or the shelving manufacturer**

Last name/first name:  
 Company:  
 Date:  
 Signature

**Assembly**



Lower the beam on the facade or raise the beam when unloading to create a slope.

**Step 1 - Beams**

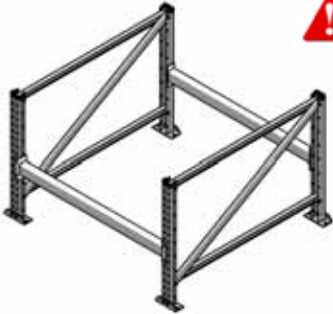

The beams must be uniformly installed. A specific drawing must be attached with every delivery.

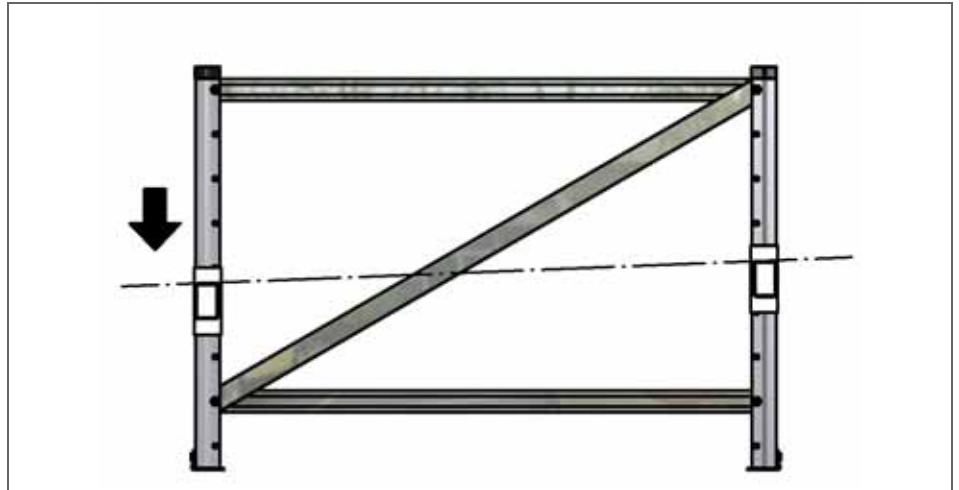

**Step 2 - Guides**

**Optional**



If full length guides are delivered, assemble the guide supports in the tubes with a mallet.

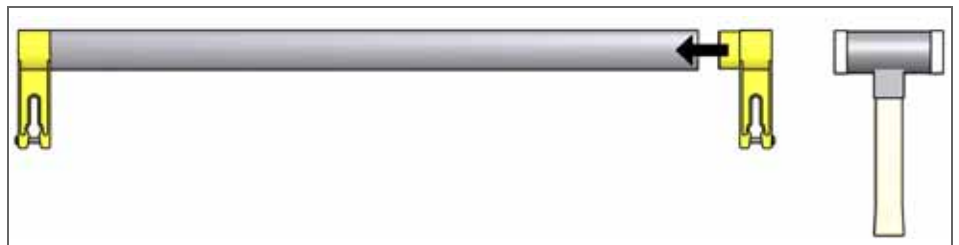

Full length guides - Module with aluminium connectors



**Fix the full length guides on the Carton Versi Flow module spacers**

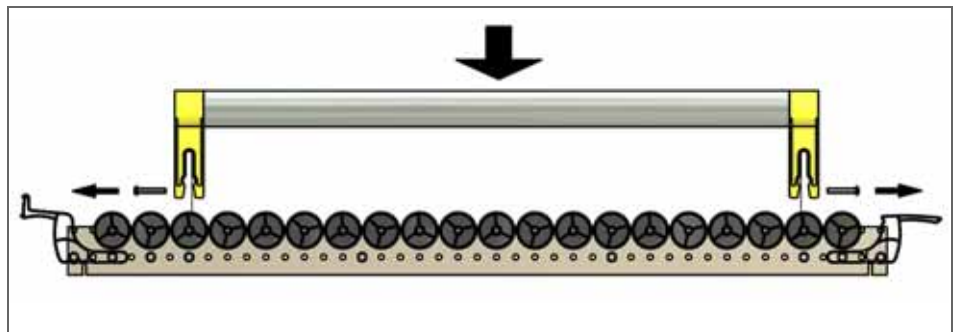

► Loosen the clamping screws from the guide. Insert the guide fully. The roller pins and the spacers must be mounted in the guide.



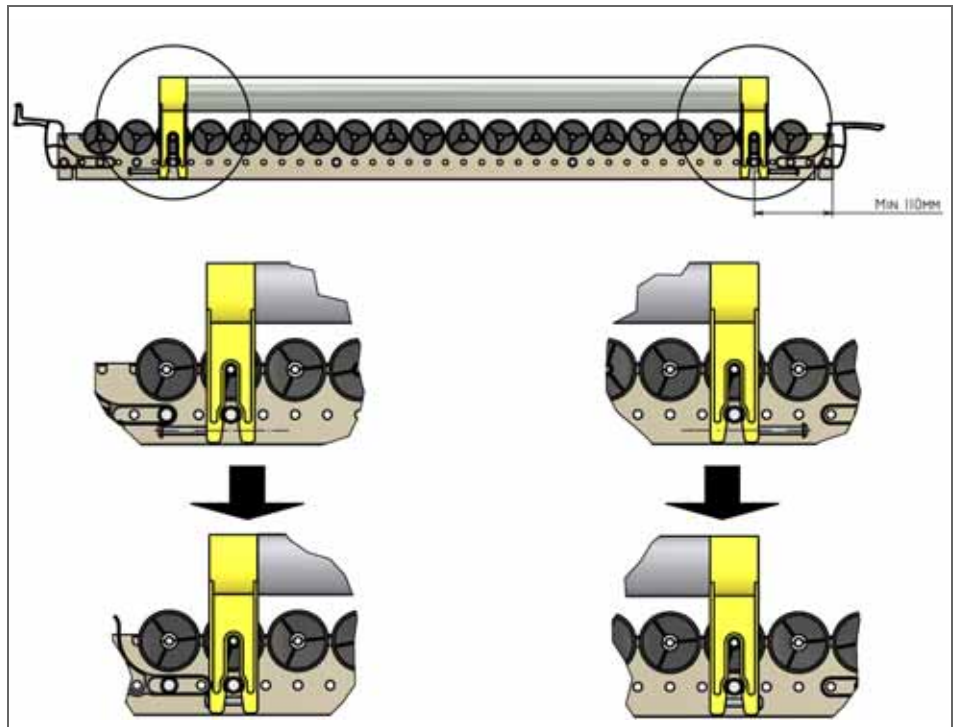

► Tighten until the guide support is immobilised.



When tightening, the guide support may get deformed to abut against the spacer.

Visual guides - Module with aluminium connectors

Fix the visual guides on the loading connectors

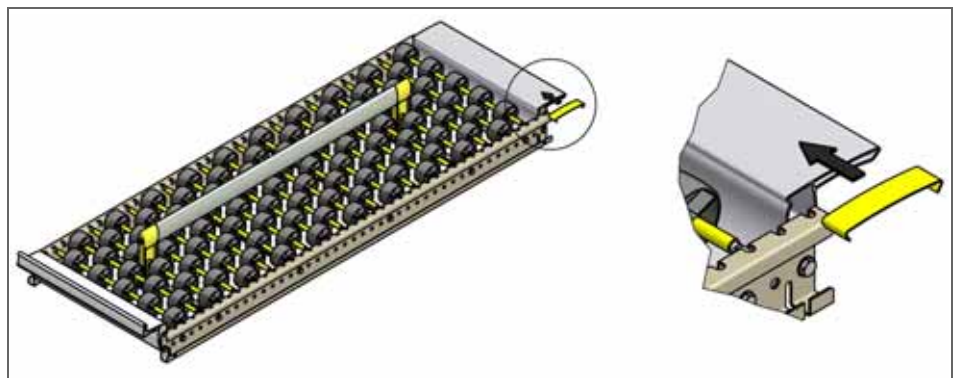

► Insert the visual guides on the loading connectors from the side.

Module with bracket

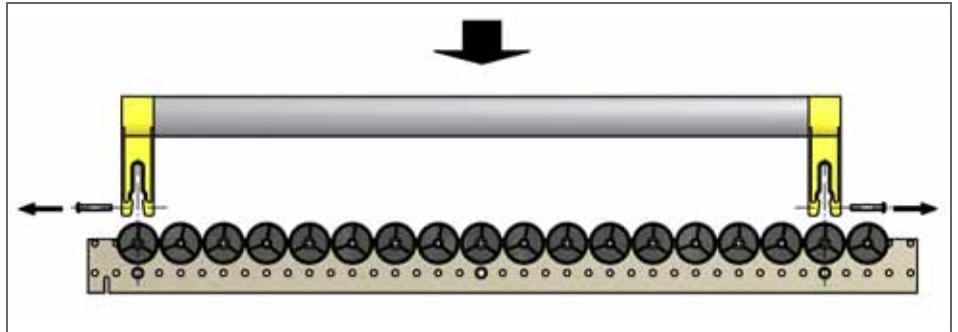

- ▶ Loosen the clamping screws from the guide. Insert the guide fully. The roller pins and spacers must be mounted in the guide.

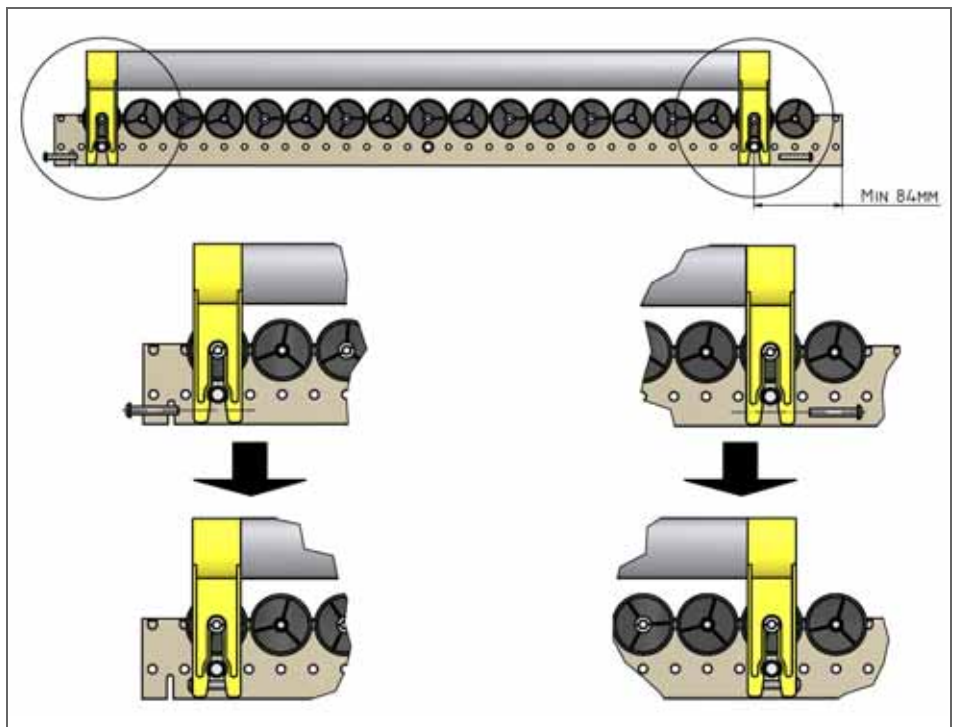

- ▶ Tighten until the guide support is immobilised. When tightening, the guide support may get deformed to abut against the spacer.

**Step 3 – Installation of modules**

Module with aluminium connectors

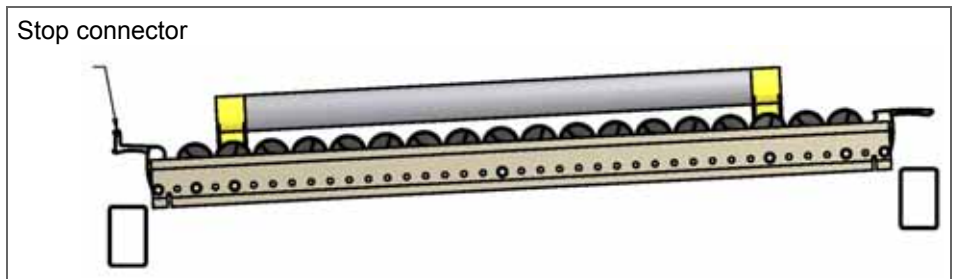
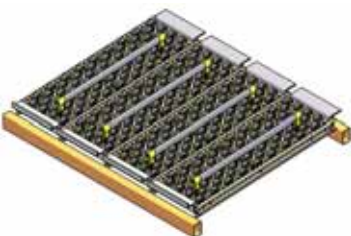

- ▶ Remove the modules between the beams ensuring that the stop connector is on the unloading side.

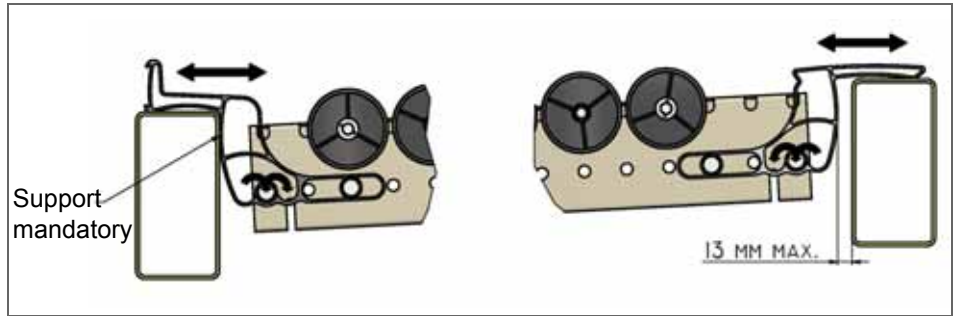

► Adjust the position of connectors so as to leave a maximum clearance of 13 mm for removal.



The stop connector always abuts against the beam on the unloading side.



Never handle the modules by holding them with the guide.

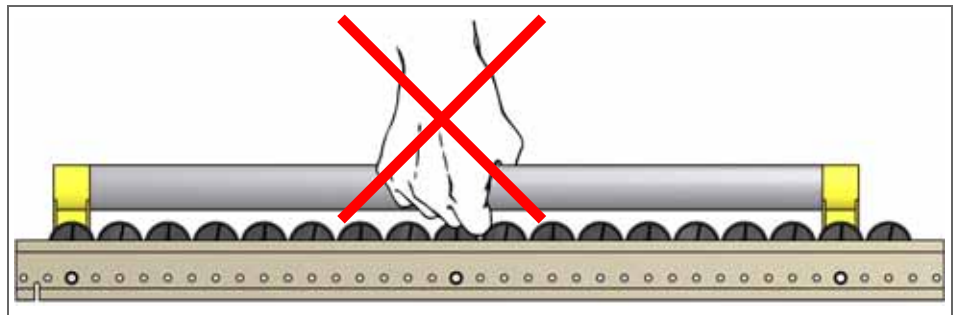

Module with brackets

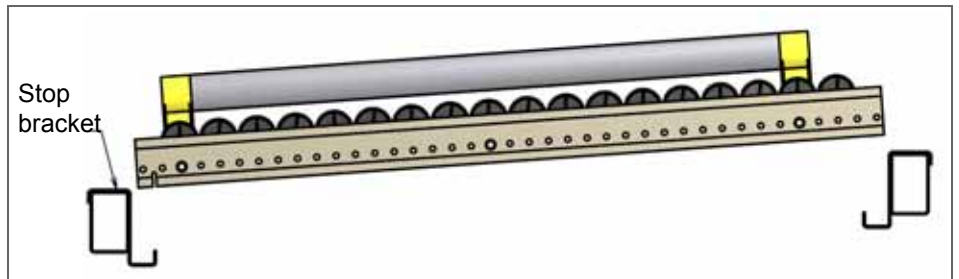
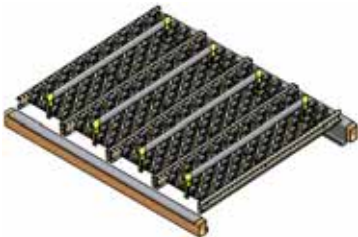

- Place the brackets on the beams on the loading and unloading side.
- Remove the modules inside the brackets

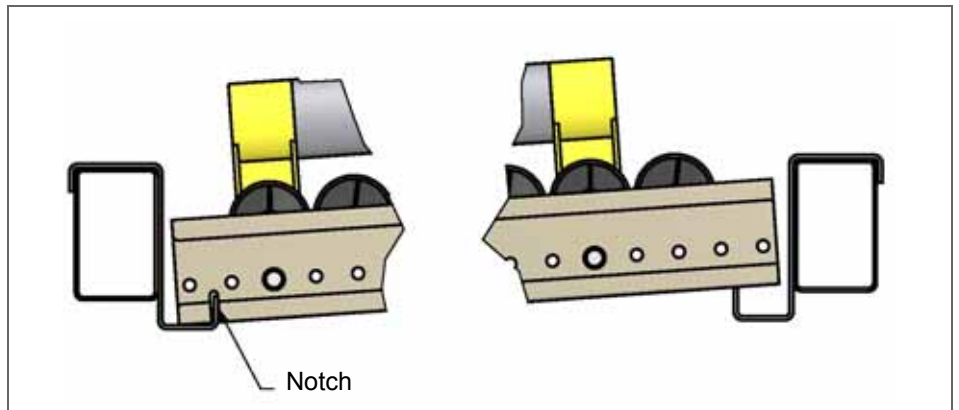

The notch of the side member enters into the bracket on the unloading side



Never handle the modules by holding them with the guide.

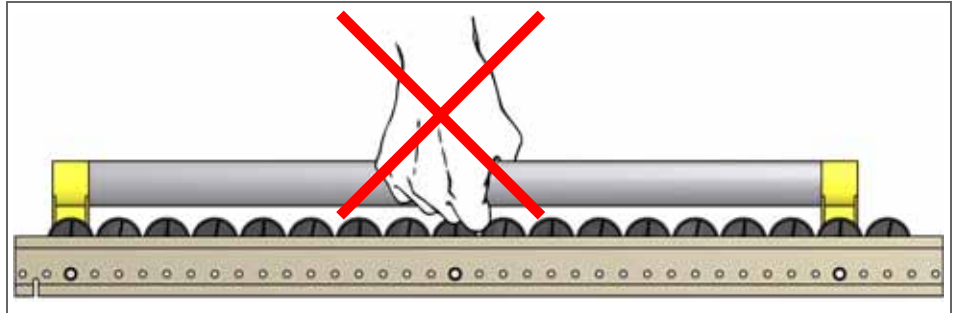

**Step 4 – Attachment of clips**

Module with connectors  
Module with brackets

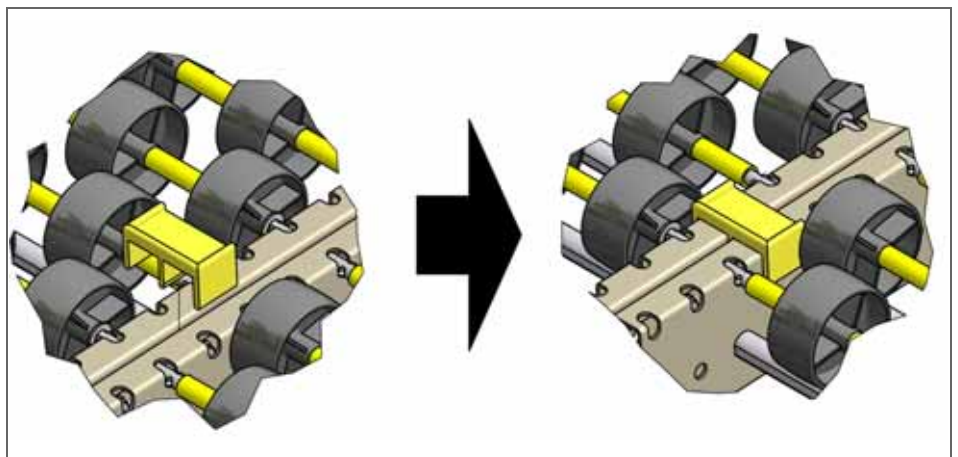
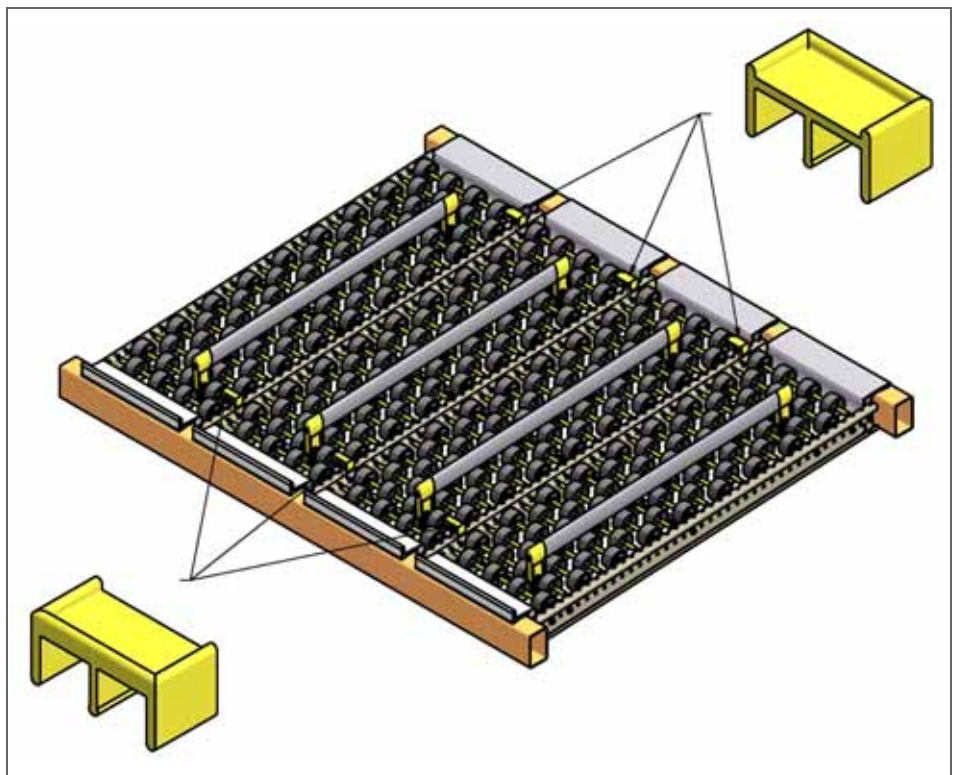

► Fix the clips on loading and at the outlet.

## Commissioning and operation

### Warnings relating to the operation



#### Warning

##### Risk of injury in case of incorrect handling

- ▶ Respect the loading direction according to the operating mode of the module (LIFO or FIFO).
- ▶ Do not insert the containers into the module if they do not enter fully.
- ▶ If a container overshoots the module, remove it immediately.
- ▶ Do not carry out the loading if the container needs to be inserted with pressure.



#### Recommendation

##### Damage in case of improper handling

Respect the comments below.

- ▶ Load carefully so as not to damage the module or products stored on it.
- ▶ Do not touch the roller pins, the module and the shelving with the handling equipment.
- ▶ Do not re-insert a container on the unloading side if sufficient space is not available in the module.
- ▶ In case a malfunction or visual damage is perceived, stop the module immediately and set up the corresponding sign.
- ▶ For all damage resulting from impacts on the shelving, modules or roller pins, inform the maintenance department of the company immediately.
- ▶ In case nuts, screws or other components have been detected on the floor, stop all levels of the bay and neighbouring bays immediately. Set up the corresponding signs.
- ▶ In case a roller pin is not fixed or has come out from its housing, stop all levels of the bay and neighbouring bays immediately. Set up the corresponding signs.
- ▶ In case a container is blocked, analyse the causes of blocking and remove it. If the container seems faulty, isolate it from the storage area.
- ▶ If the blocking of the container recurs at the same point, inform the maintenance department of the company so that they may take suitable measures.



**Before commissioning the installation, the operator must ensure that all operating personnel are trained with a view to:**

- **Specific use of a dynamic storage installation**
- **All risks inherent in a dynamic storage system, e.g., falling loads, moving loads, breaks.**

### Inspections before the first commissioning

- ▶ When connecting the storage modules and other warehouse equipment, perform the risk analysis for the complete installation.
- ▶ Check that the shelving and frames do not show any visible damage.
- ▶ Check that there are no foreign bodies in the work area.
- ▶ Respect the configuration tested during the acceptance of the installation.
- ▶ Carry out tests for all configuration modifications.

### Operation

Lock the bay if you observe the following:

- A suspicious noise
- A visibly damaged component
- A damaged shelving
- A defective attachment between the module or shelving
- A component that is disabled or operating non-compliantly
- Falling contents in the aisles

### Inspection before every commissioning

- ▶ Check that all persons present are informed and trained to use the installation and that no one is in a position of danger.
- ▶ Check that there is no visible damage on the bays and shelving.
- ▶ Check that there are no foreign bodies preventing the proper operation of the installation

### Loading a container

**Warning**



**Risk of injury in case of incorrect handling**

- ▶ Respect the loading direction according to the operating mode of the module (LIFO or FIFO).
- ▶ Do not insert the containers into the module if they do not enter fully.
- ▶ If a container overshoots the module, remove it immediately.
- ▶ Do not load if the container must be inserted with pressure.
- ▶ If the container is blocked, remove it and analyse the causes of the blockage.

**Recommendation**



**Damage in case of improper handling**

- ▶ Load carefully so as not to damage the module or products stored on it.
- ▶ After any impact or displacement of a module:
  - For a module with connectors, check the max. clearance between the beam and connector
  - For a module with brackets, check the positioning of the bracket with respect to the module
- ▶ Do not touch the roller pins, the module and the shelving with the handling equipment.
- ▶ Do not re-insert a container on the unloading side if there is insufficient space in the module.

- ▶ Check the bottom of the container for any possible damage or foreign bodies. The damaged containers must not be used in the dynamic storage module and must be evacuated from the storage area.
- ▶ Ensure that the container to be loaded forms part of the containers validated during the first commissioning, see *Inspections before the first commissioning, page 22*.
- ▶ Ensure that the loading conditions are identical to those validated during the first commissioning, see *Inspections before the first commissioning, page 22*.
- ▶ Open containers must be qualified to avoid the risk of spatter of contents during the stopping at the abutment.
- ▶ Only use containers and weights indicated in the order confirmation.
- ▶ Do not stack the containers, except after validation by test under the user customer's responsibility.



**For grasping the containers during loading and unloading, refer to the current ergonomic standards.**

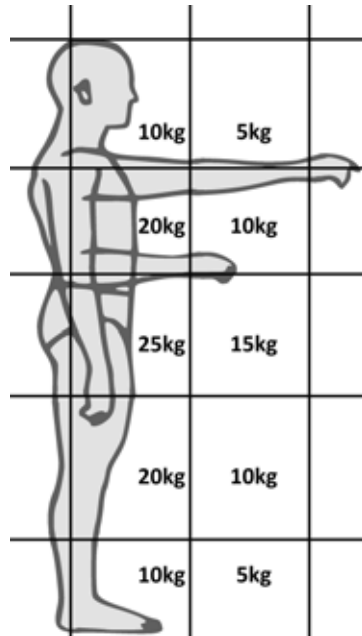

**Weight divided by 2 for women.**

## Loading and unloading method

### Loading a container

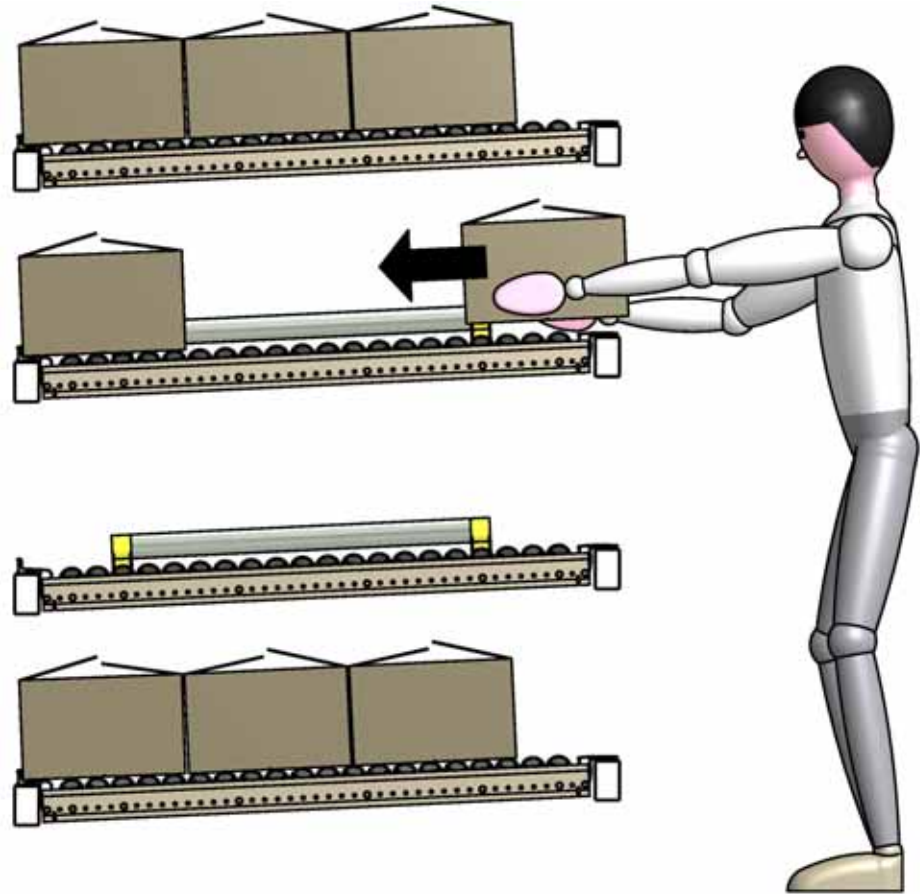

- ▶ Do not put your fingers under the container.
- ▶ Do not put your hands between the roller pins.
- ▶ Load the container in the lane axis.
- ▶ Do not release the load when it not stable.
- ▶ If a container overshoots the module, remove it immediately.
- ▶ Do not load if the container must be inserted with pressure.
- ▶ Ensure a sufficient setback distance.
- ▶ Respect the loading direction according to the operating mode of the module (LIFO or FIFO).



Unloading a container

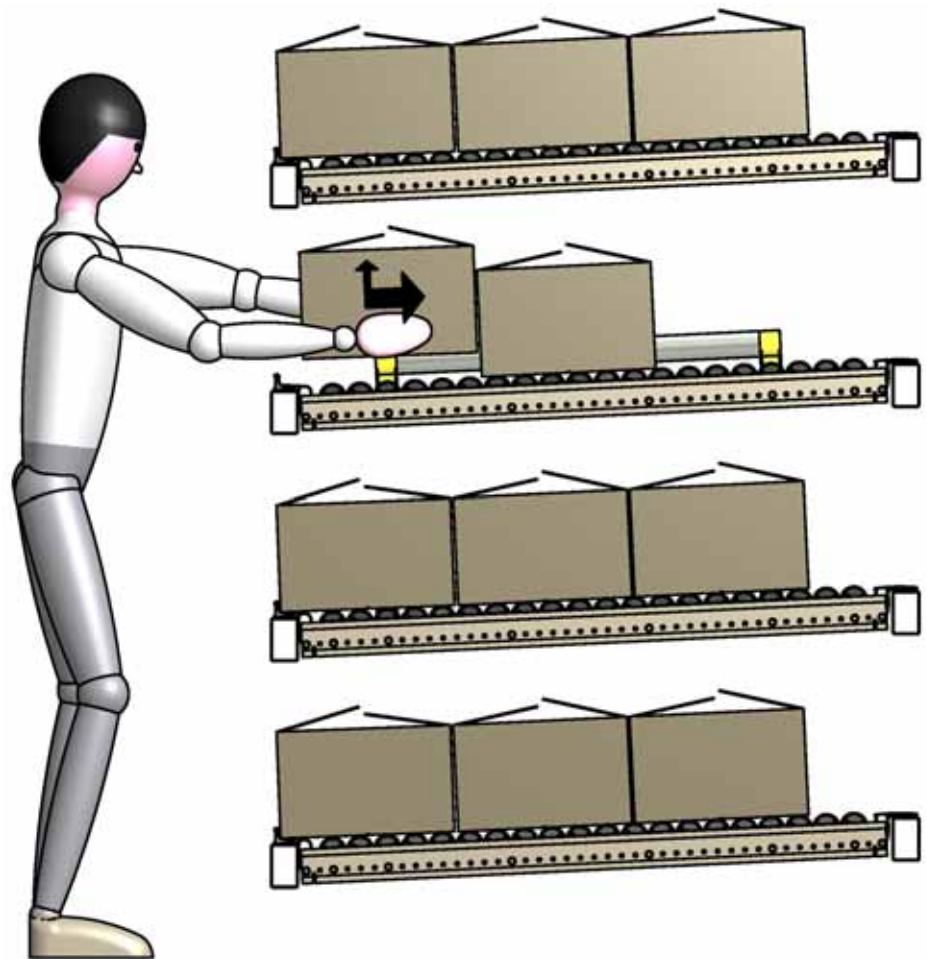

- ▶ Do not put your fingers under the container.
- ▶ Do not put your hands between the roller pins.
- ▶ Ensure a sufficient setback distance.
- ▶ For easier unloading of the container, remove it from the stop by pushing it backward and then lift it to remove it from the module.

## Cleaning, maintenance and repair

### Cleaning

#### Recommendation



##### Damage in case of improper cleaning

- ▶ Do not use abrasive products, pressurised jets or products that could oxidise or damage the equipment.
- ▶ Do not use any product not compatible with the polymers during cleaning.
- ▶ Clean the module with a dry cloth.

### Note in case of maintenance and repair

#### Warning



##### Risk of injury in case of improper intervention

- ▶ Have the intervention carried out only by qualified and regularly trained personnel in accordance with the instructions and safety guidelines.
- ▶ Wear Personal Protective Equipment (PPE).

Before any intervention, consider:

- The safety guidelines of the work area, e.g., traffic, welding, grinding, intervention duration for cold rooms.
- Specifications peculiar to the company where the installation is used.
- Technical data notified in the order confirmation.
- Maintenance procedures of different products: dynamic storage module, shelving, environment, e.g., sprinkler.

#### Preparing an intervention

- ▶ Define a safety zone around the work area.
- ▶ The safety zone includes the entire height of the bay.
- ▶ Secure the area and set up a sign, a net, etc.
- ▶ Completely empty the lane or the module concerned by the intervention before starting it.
- ▶ Ensure that the intervention area is sufficiently lit.

#### Carrying out an intervention

- ▶ At the end of the intervention, carry out a visual inspection of the part maintained so as not to leave foreign bodies or tools likely to affect the proper operation of the installation.
- ▶ Before any restarting, check the integrity of the module, shelving and its environment, e.g., sprinkler.
- ▶ Do not enter the module volumes.
- ▶ As part of an intervention, dismantle the module using the reverse installation procedure
- ▶ Replace the components only with those from Interroll.
- ▶ Never untwist a defective component. Always replace it with a new compliant component from Interroll.

## Maintenance and inspection list

In order to constantly maintain the installation in perfect operating condition, the damaged components must be systematically replaced.

Keep a record of the verifications and interventions carried out on the installation. Otherwise, the operator commits his own responsibility in case of an incident or accident on the installation, and may not claim any guarantee or indemnity on the part of Interroll.

<b>Carton Versi Flow</b>		<b>Date:</b>
<b>Element</b>	<b>Tasks/Verifications</b>	<b>Work to be carried out</b>
		<b>Executed by</b>
Roller pins	Check the proper installation	The roller pins must be held between the lateral side members. If a roller pin has come out from its housing, reposition it by following the instructions below.
	Check that the pins are not deformed.	The roller pin shaft must be straight. If it is bent, replace it by following the instructions below.
Module clips	Check the proper installation	The clips must not be released from the modules by mere manual traction (without tool). Where applicable, check the proper installation of clips
Full length guides	Broken guide support	Replace the entire guide with an Interroll guide.
	Deformed guide tube	Replace the entire guide with an Interroll guide.
Side members	Check that the side members are not deformed	If a side member is deformed replace the complete module.
Aluminium connector	Loading connector: verify the max. distance with the beam	Readjust the position of the connector if required. If the loading connector is damaged, replace the complete module.
	Stop connector the stop function	The stop connector must hold the container on the facade. If the stop connector is damaged, replace the complete module.



<b>Carton Versi Flow</b>		<b>Date:</b>	
<b>Element</b>	<b>Tasks/Verifications</b>	<b>Work to be carried out</b>	<b>Executed by</b>
Bracket	Check its functionality	The brackets must hold modules in position between the shelving beams. At the lane outlet, the bracket must hold the accumulated containers. In case of a malfunction, replace the bracket with a bracket provided or validated by Interroll.	

In case spare parts are required, Interroll is available to provide you with an estimate.

## Troubleshooting

### In case of breakdown

- ▶ Stop using the lane or lane(s) likely to get damaged by the breakdown.
- ▶ Secure the area and set up the corresponding sign.
- ▶ Ensure that the troubleshooting is carried out only by qualified maintenance personnel.
- ▶ Never try to hold a container that has been released during an operation.
- ▶ Before any restarting, check the integrity of the module, shelving and its environment, e.g., sprinkler.  
Respect the maintenance procedures of different products: dynamic storage module, shelving, environment.

**A container may be immobilised and not restart for multiple reasons, without this constituting an installation defect. Introducing a new container generally restores the operation.**

- ▶ In case a container is blocked in the middle of a lane and/or against the shelving, load another container or use a "pole" to release it.

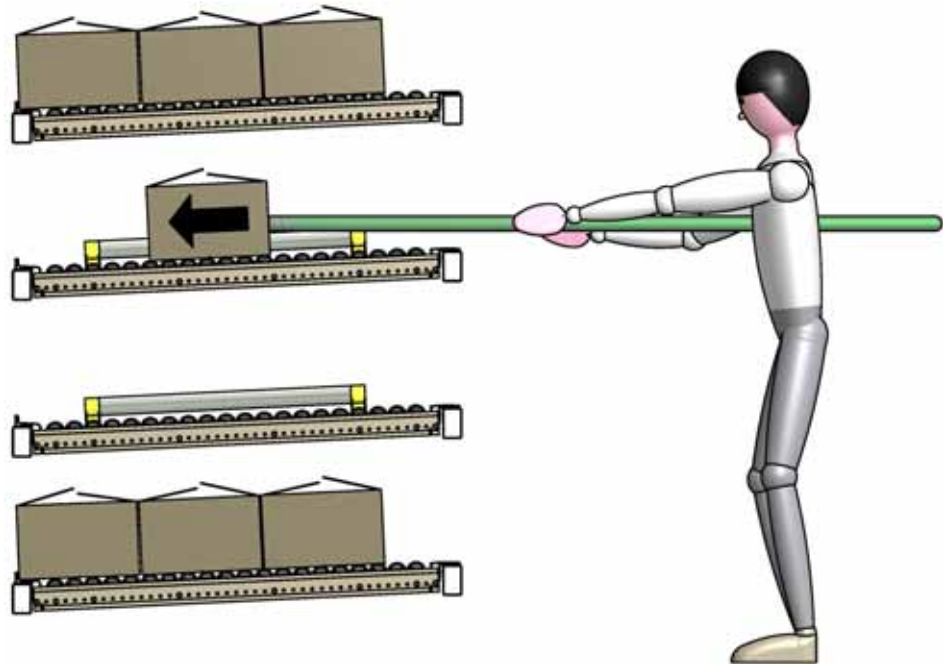

- Contents fallen on the floor** ▶ In case the contents have fallen on the floor, it is mandatory for the user to secure the area before intervention.

### Troubleshooting

Breakdown	Cause	Elimination
Blocked container	Damaged container	▶ Disable the container.
	Container not compliant with the tests carried out during the commissioning	▶ Disable the container.
	Foreign particles attached to the container	▶ Clear the foreign particles.
	Foreign particles on the module	▶ Clear the foreign particles.
	Roller pins	▶ Replace the pins in the module according to the method below.

#### Replacing or repositioning a roller pin



- ▶ Loosen all the tie-rods and nuts of the module:
  - The nuts must remain on the tie-rods to hold the side members
  - Loosen by a maximum of 10mm

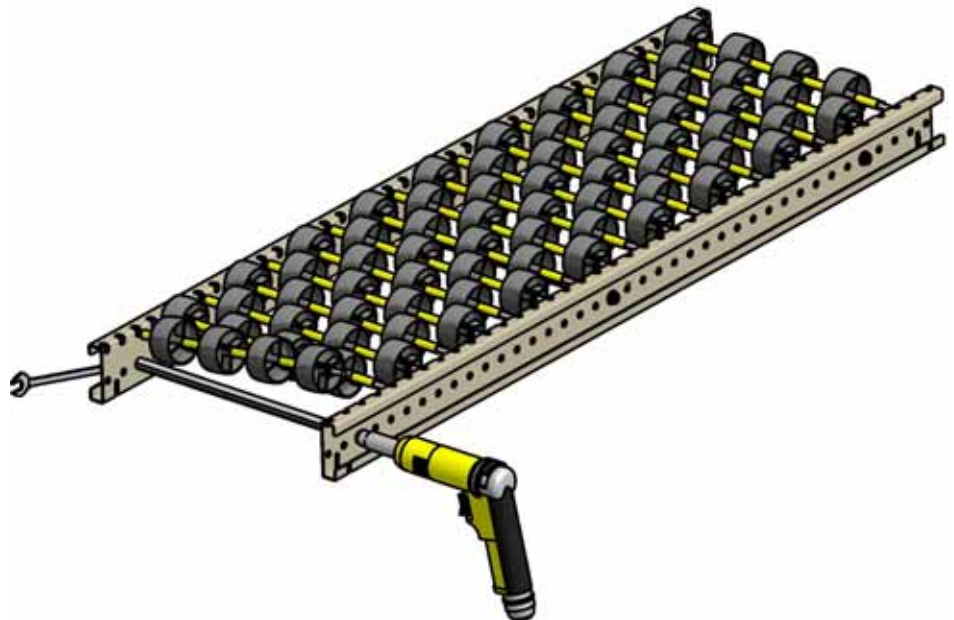

- ▶ Replace or reposition the roller pin(s).
- ▶ Tighten the tie-rods and nuts to a torque of 14 Nm.

## Disabling and discarding

### Waste removal

#### Recommendation for protecting the environment

Insofar as possible, the packaging materials must be disposed off in a system respecting the environment.

- ▶ **Wherever maintenance work and disposal equipment is concerned, respect the environmental standards and dispose off in suitable systems.**

## Appendix

### Spare parts

#### Spare part drawings

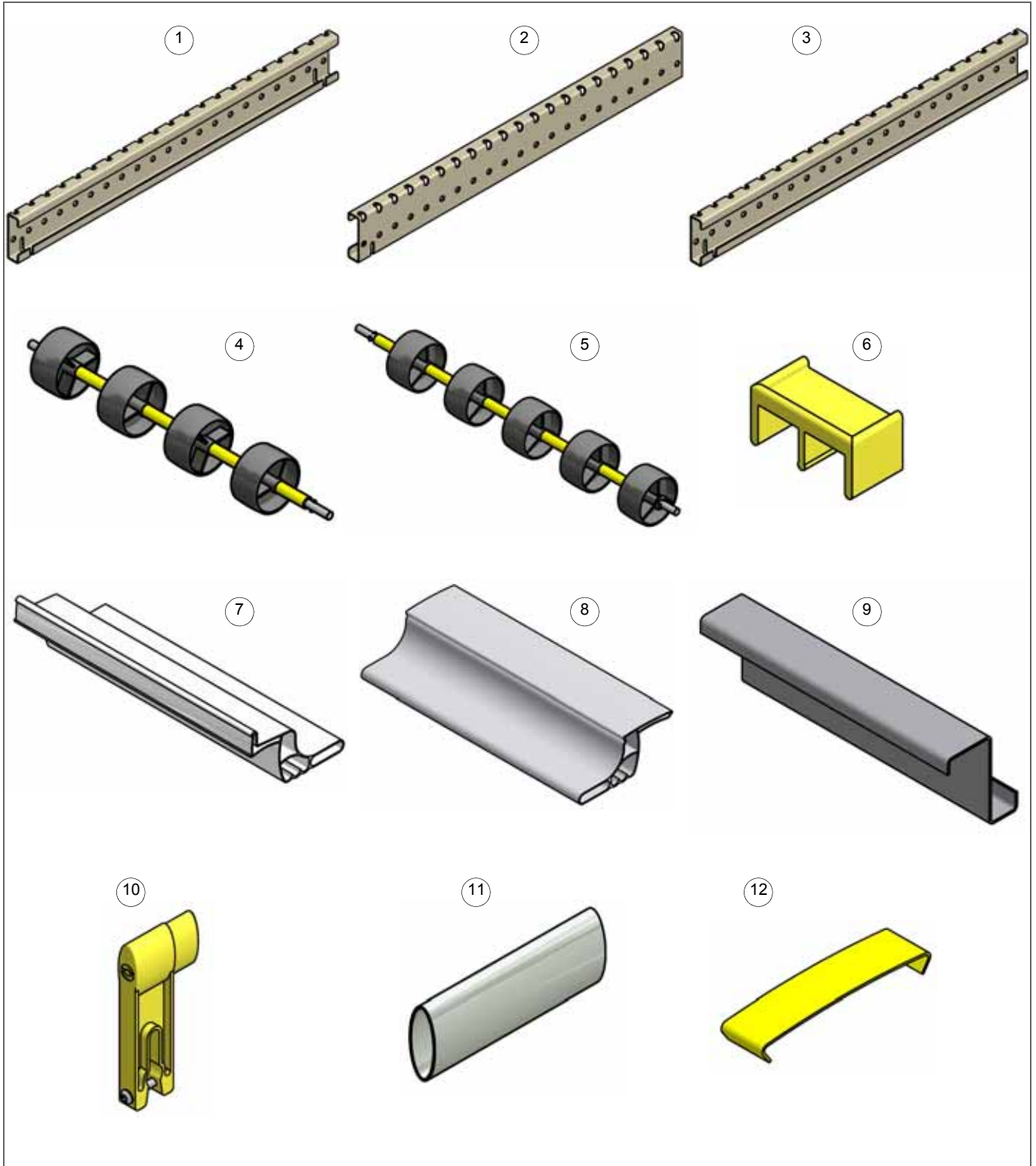



**Spare part list** Before the order, confirm the references by Interroll by communicating the machine no. present on the rating plate.

Recommended stock status:

A = Stock maintenance, B = Recommended stock, C = Optional stock

<b>Machine no.</b>				
<b>No.</b>	<b>Name</b>	<b>Reference</b>	<b>Quantity</b>	<b>Stock status</b>
(1)	Symmetrical side member	A13110561		C
(2)	Right side member	F14013072		C
(3)	Left side member	F14013073		C
(4)	4-Roller pin	A13100462		A
(5)	5-Roller pin	A13100463		A
(6)	Side member clip	A13100464		A
(7)	Stop connector	A13010766		C
(8)	Loading connector	A13010767		C
(9)	Bracket	Adapted to the order		C
(10)	Guide support	CA-1100406		C
(11)	Guide tube	F13091233		C
(12)	Visual guide	A14012761		C

These components can only be replaced by qualified maintenance personnel. This table is only indicative based on the general requirements observed at the users' premises. It is up to the user to adapt his stock according to the specific requirements of his use.

