

Operating manual

Interroll MultiControl ASi Bus

24 V / 48 V



Interroll Software & Electronics GmbH
Im Südpark 183
4030 Linz
AUSTRIA

www.interroll.com

Content

We strive for the accuracy, timeliness and completeness of the information and have carefully prepared the contents in this document. Regardless of this, errors and changes are expressly reserved.

Copyright/industrial property rights

Any texts, images, graphics and the like, as well as their arrangement, are subject to protection under copyright and other laws of protection. The reproduction, modification, transmission or publication of any part of this document or of the entire document in any form is prohibited.

The document serves the exclusive purposes of information and of operation in accordance with the regulations and does not justify any counterfeiting of the products concerned.

All signs contained in this document (protected marks, such as logos and trade names) are the property of Interroll Holding AG, CH or of third parties and must not be used, copied or distributed without prior written consent.

1	Information	5
1.1	Information about this operating manual	5
1.2	Warning notices in this document	6
1.3	Symbols	7
2	Interroll MultiControl ASi Bus 24 V / 48 V	8
2.1	Safety notes	8
2.2	Technical specifications	10
2.3	Front view and connections	11
2.4	LED status indicator	13
2.6	Dimensions	15
2.7	Montage	16
	Mounting types	16
2.8	Line termination with sealing profiles	17
2.9	Addressing with ASi Master and ASIMON	18
2.10	Process images	19
	4 Byte Process image	19
	8 Byte Process image	20
	14 Byte Process image	21
2.11	Translation of the original Declaration of conformity	22
2.12	UKCA Declaration of conformity	23



1 Information

1.1 Information about this operating manual

The operating instructions are part of the Interroll product(s) mentioned in the title and contain important notes and information on the various operating phases of the product(s) mentioned.

Like all our products, the operating instructions are also subject to constant monitoring and will be adjusted if necessary.

The currently applicable version of this operating manual can be found online at:

www.interroll.com

All the information and advice in this operating manual has been compiled with respect to applicable standards and regulations as well as the current state of the art.

- To ensure safe and faultless operation and to fulfil any warranty claims that may apply, read this operating manual first and observe its instructions.
- Keep this operating manual within close reach of the DriveControl.
- Pass this operating manual onto every subsequent owner or user.



The manufacturer assumes no liability for damage and malfunctions that occur as a result of non-compliance with this operating manual.



Should you still have any unanswered questions after reading this operating manual, please contact Interroll customer service. Contact details for your region can be found online at www.interroll.com

Please direct any comments and suggestions regarding our operating manuals to manuals@interroll.com

Information

1.2 Warning notices in this document

Warning notices are provided in the context in which danger can occur and describe the nature of the danger in question. They are structured according to the following examples:



SIGNAL WORD

Type and source of hazard

Consequence(s) in the event of non-compliance

➤ Measure(s) for avoiding hazard

Signal words indicate the type and severity of the consequences if measures to avoid the hazard are not observed.



DANGER

Denotes an imminent hazard.

If measures to avoid the hazard are not observed, death or severe injury will occur.

➤ Preventive measures



WARNING

Denotes a potentially hazardous situation.

If measures to avoid the hazard are not observed, death or severe injury may occur.

➤ Preventive measures



CAUTION

Denotes the possibility of a hazardous situation.

If measures to avoid the hazard are not observed, minor or moderate injury may occur.

➤ Preventive measures

NOTE

Denotes a situation that can lead to material damage.

- Preventive measures

1.3 Symbols



This symbol indicates useful and important information.

- ✓ This symbol indicates a requirement that must be fulfilled before carrying out assembly or repair work.



This symbol indicates general information relating to safety.

- This symbol indicates an action that needs to be performed.
- This symbol indicates a listed item.

Interroll MultiControl ASi Bus 24 V / 48 V

2 Interroll MultiControl ASi Bus 24 V / 48 V

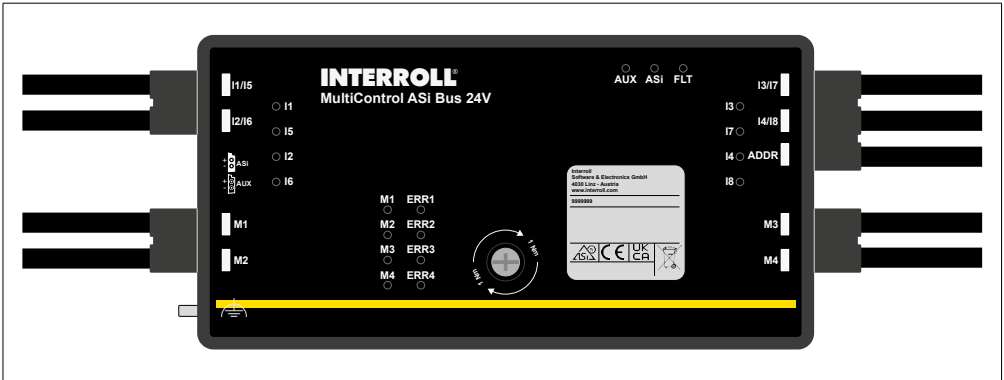

Read instruction:

Before working with this unit: read these instructions carefully and completely. All notes on safety and specifications of the device manual and the manual for the configuration software are to be considered!

2.1 Safety notes



Professional installation:

Electrical installation is to be performed by qualified personnel. During installation, make sure that supply and signal cables and also the ASi bus cable are laid separately from high-voltage cables. In the switching cabinet, it must be ensured that appropriate spark extinction equipment is used for contactors. If drive motors and brakes are used, observe the installation instructions in the corresponding operating manual. Please note that the maximum cable length of the ASi bus cable is 100 m. Cable lengths longer than this require the use of suitable cable extensions.

Interroll MultiControl ASi Bus 24 V / 48 V



WARNING

HAZARDOUS VOLTAGE!

- Before any installation, maintenance or modification work: Disconnect your system from the supply network. Ensure that it cannot be reconnected inadvertently!
-



Short circuits between the pins of the motor socket can lead to a device defect!



Observe operating voltage!

48 VDC must not be connected to

- Devices with 24 VDC operating voltage (observe data sheet of the manufacturer)
- the ASi connection of the device
- the ASi gateway!

Interroll MultiControl ASi Bus 24 V / 48 V

2.2 Technical specifications

General	
Motor rollers	4 x Interroll (EC5000 AI, 24 V / 48 V, 20 W / 35 W / 50 W)
ASi	
Address	1 ASi-5
Required ASi specification of the master	ASi-5
Rated operational voltage	30 V (18 ... 31,6 V)
Max. current consumption	320 mA
Max. current consumption without sensor/actuator supply	80 mA
AUX	
Voltage	24 V (18 ... 30 V) 48 V (45 ... 51 V)
Protection rate	IP54
Can be used with passively safe-switched AUX cable up to SIL3/PLe	Yes
Ambient temperature in operation	-30 °C ... +70 °C
Ambient temperature during transport and storage	-25 °C ... +85 °C
Altitude of installation site	Max. 2000 m

Interroll MultiControl ASi Bus 24 V / 48 V

2.3 Front view and connections

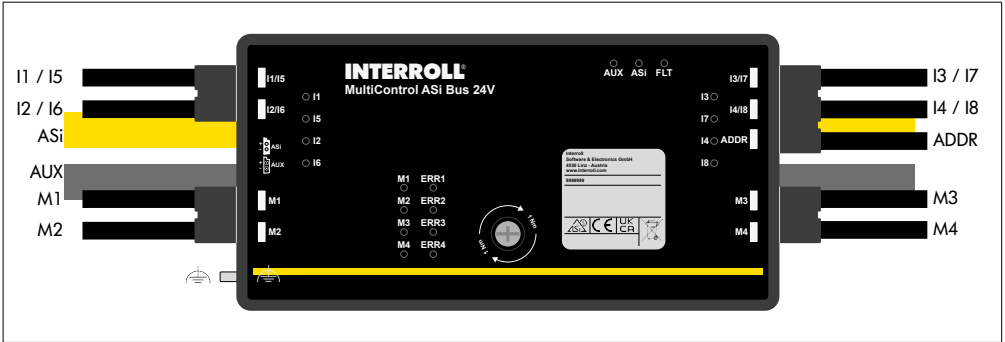

Connections

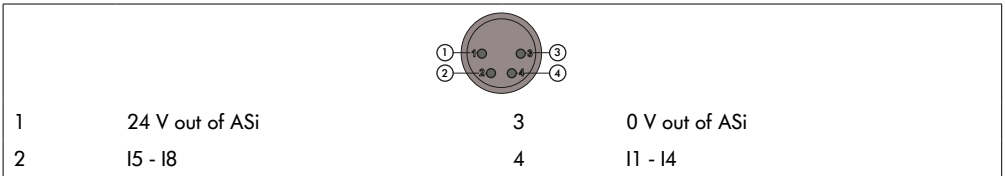

Connections

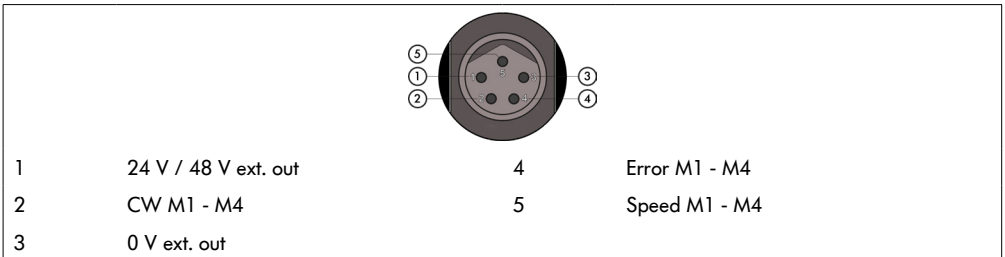













Connections











Interroll MultiControl ASi Bus 24 V / 48 V

Signal	Description
24 V out of ASi	Power supply, out of ASi, positive pole (sensor supply)
0 V out of ASi	Power supply, out of ASi, negative pole (sensor supply)
Ix	Digital input x
24 V ext out	Power supply, out of external voltage, positive pole (AUX)
0 V ext out	power supply, out of external voltage, negative pole (AUX)
CW Mx (clockwise)	Direction of rotation of motor x
Error Mx	Error at the motor x
Speed Mx	Speed of the motor x
ASi	ASi profile cable for data and power transmission
AUX	ASi profile cable for additional auxiliary power

2.4 LED status indicator

LED	Description	
		ASi voltage on
		Address „000“
ASi / FLT		See Peripheral fault
		Flashing pattern for identification of the device (e.g. can be activated from ASIMON360)
		Warning message, see diagnostics software for further details
		Firmware update is running
		
AUX		External supply voltage on
M1 ... Mn		State of motor outputs
		Motor fuse is blown out
ERR1 ... ERRn		Error message motor or motor not connected to module
		ERR LED is not controlled when the motor ports are deactivated

Explanation

		Alternate flashing
		Simultaneous flashing
		LED Off
		LED On

Interroll MultiControl ASi Bus 24 V / 48 V

Peripheral fault

- Overload output
- AUX voltage is missing
- Overload sensor supply
- Motor fuse blown or motor in fault condition or not connected to the module

Interroll MultiControl ASi Bus 24 V / 48 V

2.6 Dimensions

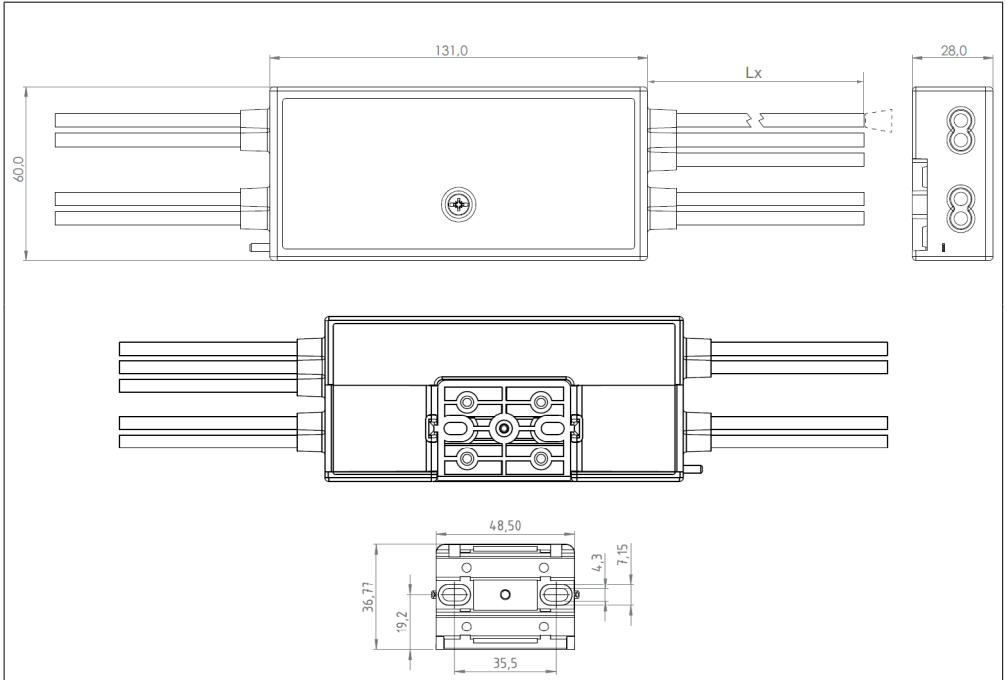





Interroll MultiControl ASi Bus 24 V / 48 V

2.7 Montage

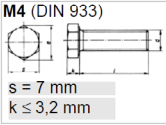
Mounting types

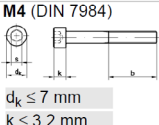
On ASi substructure module

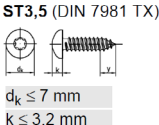
<i>angetriebene Mutter // driven nut// écrou entraîné // dado azionato // tuerca accionada</i>		<i>angetriebener Schraubenkopf // driven screwhead // tête de vis entraîné // testa del bullone azionato // cabeza del tornillo accionada</i>	
M4 (DIN 933)  s = 7 mm k ≤ 3,2 mm		M4 (DIN 7984)  d _k ≤ 7 mm k ≤ 3,2 mm	
		ST3,5 (DIN 7981 TX)  d _k ≤ 7 mm k ≤ 3,2 mm	



Use copper conductors only!

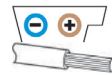

CAUTION

Risk of stab wound!

- The housing includes sharp parts - handle with care!

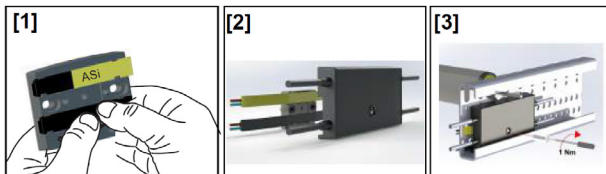

NOTE

Verify functionality correct placement of the gaskets!

Avoid direct sunlight.

Interroll MultiControl ASi Bus 24 V / 48 V

2.8 Line termination with sealing profiles

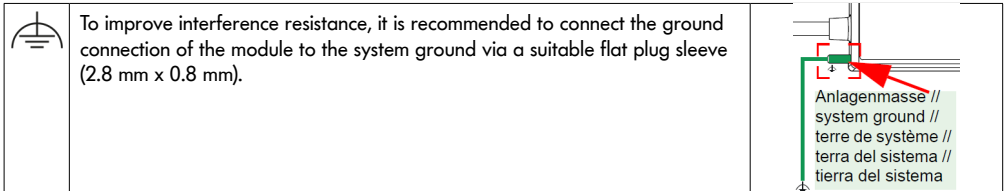
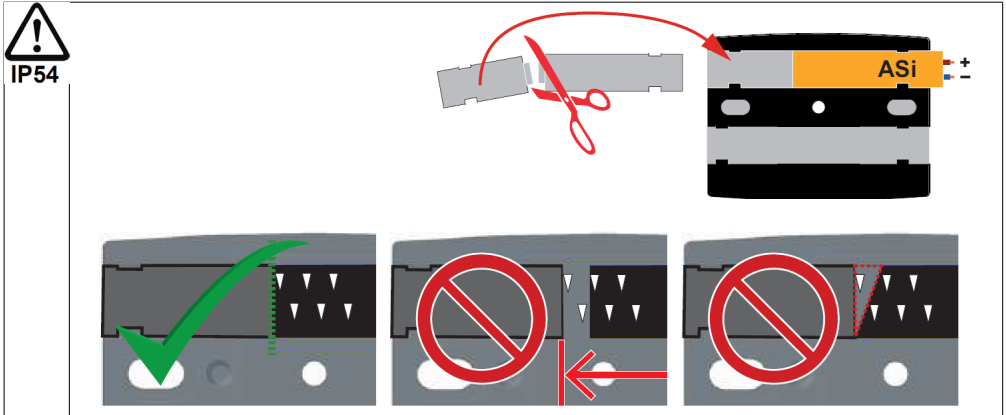

Interroll MultiControl ASi Bus 24 V / 48 V

2.9 Addressing with ASi Master and ASIMON

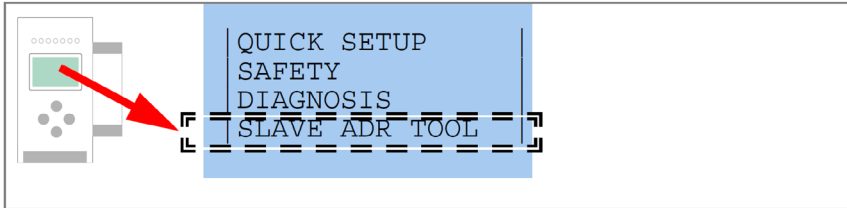

The addressing of the device can be set via the display menu. For further information, please refer to the documentation of the gateway.

Addressing is possible also with hand addressing devices.

All addresses of the device can be set via ASIMON360 / ASi Control Tools360. For further information, please refer to the documentation.

2.10 Process images

4 Byte Process image

Inputs		
I1	Byte 0, Bit 0	I1 Standard Input
I2	Byte 0, Bit 1	I2 Standard Input
I3	Byte 0, Bit 2	I3 Standard Input
I4	Byte 0, Bit 3	I4 Standard Input
I5	Byte 0, Bit 4	I5 Standard Input
I6	Byte 0, Bit 5	I6 Standard Input
I7	Byte 0, Bit 6	I7 Standard Input
I8	Byte 0, Bit 7	I8 Standard Input
Error M1	Byte 1, Bit 0	Error M1 Standard Input
Error M2	Byte 1, Bit 1	Error M2 Standard Input
Error M3	Byte 1, Bit 2	Error M3 Standard Input
Error M4	Byte 1, Bit 3	Error M4 Standard Input
Fuse blow M1	Byte 2, Bit 0	Fuse blow M1 Standard Input
Fuse blow M2	Byte 2, Bit 1	Fuse blow M2 Standard Input
Fuse blow M3	Byte 2, Bit 2	Fuse blow M3 Standard Input
Fuse blow M4	Byte 2, Bit 3	Fuse blow M4 Standard Input
Voltage Error	Byte 2, Bit 5	Voltage Error Standard Input
Temperature Error	Byte 2, Bit 6	Temperature Error Standard Input
Motor		
Speed M1	Byte 0	Speed M1 Analog Output
Speed M2	Byte 1	Speed M2 Analog Output
Speed M3	Byte 2	Speed M3 Analog Output
Speed M4	Byte 3	Speed M4 Analog Output

Interroll MultiControl ASi Bus 24 V / 48 V

8 Byte Process image

Inputs			
I1	Byte 0, Bit 0		I1 Standard Input
I2	Byte 0, Bit 1		I2 Standard Input
I3	Byte 0, Bit 2		I3 Standard Input
I4	Byte 0, Bit 3		I4 Standard Input
I5	Byte 0, Bit 4		I5 Standard Input
I6	Byte 0, Bit 5		I6 Standard Input
I7	Byte 0, Bit 6		I7 Standard Input
I8	Byte 0, Bit 7		I8 Standard Input
Error M1	Byte 1, Bit 0	Standard Input	Error M1 Standard Input
Error M2	Byte 1, Bit 1		Error M2 Standard Input
Error M3	Byte 1, Bit 2		Error M3 Standard Input
Error M4	Byte 1, Bit 3		Error M4 Standard Input
Fuse blow M1	Byte 2, Bit 0		Fuse blow M1 Standard Input
Fuse blow M2	Byte 2, Bit 1		Fuse blow M2 Standard Input
Fuse blow M3	Byte 2, Bit 2		Fuse blow M3 Standard Input
Fuse blow M4	Byte 2, Bit 3		Fuse blow M4 Standard Input
Voltage Error	Byte 2, Bit 5		Voltage Error Standard Input
Temperature Error	Byte 2, Bit 6		Temperature Error Standard Input
Motor			
AUX Voltage (mV)	Byte 4 - Byte 5	Analog Input	AUX Voltage (mV) Analog Input
Speed M1	Byte 0	Analog Output	Speed M1 Analog Output
Speed M2	Byte 1		Speed M2 Analog Output
Speed M3	Byte 2		Speed M3 Analog Output
Speed M4	Byte 3		Speed M4 Analog Output
Ramp M1	Byte 4		Ramp M1 Analog Output
Ramp M2	Byte 5		Ramp M2 Analog Output
Ramp M3	Byte 6		Ramp M3 Analog Output
Ramp M4	Byte 7		Ramp M4 Analog Output

Interroll MultiControl ASi Bus 24 V / 48 V

14 Byte Process image

Inputs		
I1	Byte 0, Bit 0	I1 Standard Input
I2	Byte 0, Bit 1	I2 Standard Input
I3	Byte 0, Bit 2	I3 Standard Input
I4	Byte 0, Bit 3	I4 Standard Input
I5	Byte 0, Bit 4	I5 Standard Input
I6	Byte 0, Bit 5	I6 Standard Input
I7	Byte 0, Bit 6	I7 Standard Input
I8	Byte 0, Bit 7	I8 Standard Input
Error M1	Byte 1, Bit 0	Error M1 Standard Input
Error M2	Byte 1, Bit 1	Error M2 Standard Input
Error M3	Byte 1, Bit 2	Error M3 Standard Input
Error M4	Byte 1, Bit 3	Error M4 Standard Input
Fuse blow M1	Byte 2, Bit 0	Fuse blow M1 Standard Input
Fuse blow M2	Byte 2, Bit 1	Fuse blow M2 Standard Input
Fuse blow M3	Byte 2, Bit 2	Fuse blow M3 Standard Input
Fuse blow M4	Byte 2, Bit 3	Fuse blow M4 Standard Input
Voltage Error	Byte 2, Bit 5	Voltage Error Standard Input
Temperature Error	Byte 2, Bit 6	Temperature Error Standard Input
Motor		
AUX Voltage (mV)	Byte 4 - Byte 5	AUX Voltage (mV) Analog Input
Motor Current M1 (mA)	Byte 6 - Byte 7	Motor Current M1 (mA) Analog Input
Motor Current M2 (mA)	Byte 8 - Byte 9	Motor Current M2 (mA) Analog Input
Motor Current M3 (mA)	Byte 10 - Byte 11	Motor Current M3 (mA) Analog Input
Motor Current M4 (mA)	Byte 12 - Byte 13	Motor Current M4 (mA) Analog Input
Speed M1	Byte 0	Speed M1 Analog Output
Speed M2	Byte 1	Speed M2 Analog Output
Speed M3	Byte 2	Speed M3 Analog Output
Speed M4	Byte 3	Speed M4 Analog Output
Ramp M1	Byte 4	Ramp M1 Analog Output
Ramp M2	Byte 5	Ramp M2 Analog Output
Ramp M3	Byte 6	Ramp M3 Analog Output
Ramp M4	Byte 7	Ramp M4 Analog Output

Interroll MultiControl ASi Bus 24 V / 48 V

2.11 Translation of the original Declaration of conformity

EU Declaration of conformity

EMC Directive 2014/30/EU

RoHS Directive 2011/65/EU

The manufacturer

Interroll Software & Electronics GmbH
Im Südpark 183
4030 Linz
AUSTRIA

hereby declares that the

- **Interroll MultiControl ASi Bus 24V**

conforms to the applicable provisions and the associated CE marking in accordance with the aforementioned Directives.

List of the coordinated standards that have been applied:

EN 62026-2:2013
EN 61000-6-2:2005/AC:2005
EN 61000-6-4:2007/A1:2011
EN 61131-2:2007
EN IEC 63000:2018

Authorised for compiling technical documentation:

Interroll Software & Electronics GmbH, Im Südpark 183, 4030 Linz



Andreas Eglseer
Managing Director, Interroll Software & Electronics GmbH
Linz, 01.10.2022

2.12 UKCA Declaration of conformity

Declaration of conformity

UK Electromagnetic Compatibility Regulations 2016

UK Restriction of the Use of Certain Hazardous Substances in
Electrical and Electronic Equipment Regulations 2012

The manufacturer

Interroll Software & Electronics GmbH
Im Suedpark 183
4030 Linz
AUSTRIA

hereby declares that the

- **Interroll MultiControl ASi Bus 24V**

**conforms to the applicable provisions and the associated UKCA marking
in accordance with the aforementioned Directives.**

Authorised for compiling technical documentation:
Interroll Software & Electronics GmbH, Im Suedpark 183, 4030 Linz



Andreas Eglseer
Managing Director, Interroll Software & Electronics GmbH
Linz, 01.10.2022

INSPIRED BY EFFICIENCY

EN | 02/2023 | Version 1.1